

**TRAILING EDGE PRODUCT - MINIMUM ORDER APPLIES
PRODUCT MAY BE MADE OBSOLETE WITHOUT NOTICE**



Elm Road, West Chirton, NORTH SHIELDS, Tyne & Wear
NE29 8SE, England Tel. +44 (0191) 2930500 Fax. +44 (0191) 2590997

128K x 8 SRAM

MSM8128 - 85/10/12

Issue 4.4 : February 2000

Description

The MSM8128 is a 1Mbit monolithic SRAM organised as 128K x 8. It is available in with access times of 85, 100 & 120ns. It has a low power standby version and has 3.0V battery backup capability. It is directly TTL compatible and has common data inputs and outputs. Two pinout variants (single and dual CS) are available. All versions may be screened in accordance with MIL-STD-883.

131,072 x 8 CMOS Static RAM

Features

- Access Times of 85/100/120 ns
- JEDEC standard Dual \overline{CS} footprints.
- Operating Power 605 mW (max)
- Low Power Standby (-L) 2.53 mW (max)
- Low Voltage Data Retention.
- Completely Static Operation
- Directly TTL compatible.
- May be processed in accordance with MIL-STD-883

Block Diagram

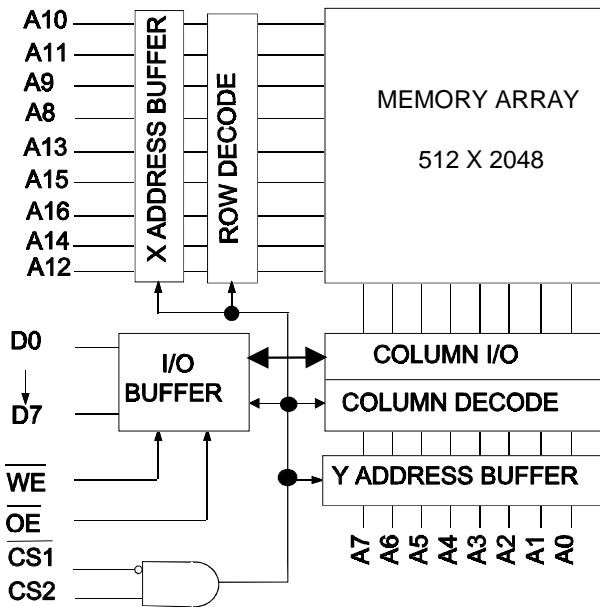

Pin Definition

NC	1	32	VCC
A16	2	31	A15
A14	3	30	CS2
A12	4	29	WE
A7	5	28	A13
A6	6	27	A8
A5	7	26	A9
A4	8	25	A11
A3	9	24	OE
A2	10	23	A10
A1	11	22	CS1
A0	12	21	D7
D0	13	20	D6
D1	14	19	D5
D2	15	18	D4
GND	16	17	D3

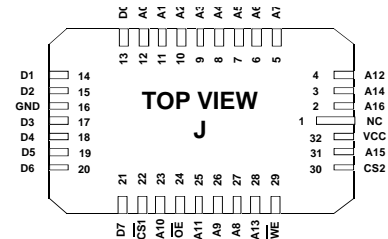

See Page 9 for X pinout

Pin Functions

- A0-A16** Address Inputs
- D0-7** Data Input/Output
- CS1** Chip Select 1
- CS2** Chip Select 2
- OE** Output Enable
- WE** Write Enable
- NC** No Connect
- V_{cc}** Power (+5V)
- GND** Ground

Package Details

Pin Count	Description	Package Type
32	Flatpack	G
32	LCC	W
32	JLCC	J

Package details on pages 8 & 9.

DC OPERATING CONDITIONS**Absolute Maximum Ratings**

Voltage on any pin relative to V_{SS}	V_T	-0.5V	to	+7.0	V
Power Dissipation	P_T			1	W
Storage Temperature	T_{STG}	-55	to	+150	°C

Notes : (1) Stresses above those listed may cause permanent damage to the device. This is a stress rating only and functional operation of the device at these or any other conditions above those indicated in the operational sections of this specification is not implied. Exposure to absolute maximum rating conditions for extended periods may affect device reliability.

Recommended Operating Conditions

		<i>min</i>	<i>typ</i>	<i>max</i>	
Supply Voltage	V_{CC}	4.5	5.0	5.5	V
Input High Voltage	V_{IH}	2.2	-	5.8	V
Input Low Voltage	V_{IL}	-0.3	-	0.8	V
Operating Temperature	T_A	0	-	70	°C
	T_{AI}	-40	-	85	°C (I suffix)
	T_{AM}	-55	-	125	°C (M , MB suffix)

DC Electrical Characteristics ($V_{CC} = 5.0V \pm 10\%$, $T_A = -55^\circ\text{C}$ to $+125^\circ\text{C}$)

Parameter	Symbol	Test Condition	<i>min</i>	<i>typ</i>	<i>max</i>	Unit
Input Leakage Current	I_{LI}	$\overline{V_{IH}}=0V$ to V_{CC}	-1	-	1	μA
Output Leakage Current	I_{IO}	$\overline{CS1}=V_{IH}$, $CS2 = V_{IL}$, $V_{IO}=0V$ to V_{CC} , $\overline{OE}=V_{IH}$	-1	-	1	μA
Average Supply Current	I_{CC1}	Min. Cycle, $V_{IN}=V_{IL}$ or V_{IH}	-	-	110	mA
Standby Supply Current	I_{SB1}	$\overline{CS1}=V_{IH}$, $CS2 = V_{IL}$, I/P's static	-	-	3.5	mA
	I_{SB2}	$\overline{CS1} \geq V_{CC} - 0.2V$, $0.2V \geq CS2 \geq V_{CC} - 0.2V$, $V_{IN} \geq 0.2V$	-	-	460	μA
Output Voltage	V_{OL}	$I_{OL} = 2.1 \text{ mA}$	-	-	0.4	V
	V_{OH}	$I_{OH} = -1.0 \text{ mA}$	2.4	-	-	V

Capacitance ($V_{CC}=5V \pm 10\%$, $T_A=25^\circ\text{C}$)

Parameter	Symbol	Test Condition	<i>typ</i>	<i>max</i>	Unit
I/P Capacitance	C_{IN}	$V_{IN}=0V$	-	8	pF
I/O Capacitance	C_{IO}	$V_{IO}=0V$	-	10	pF

Note: This parameter is sampled and not 100% tested.

Operating Modes

The table below shows the logic inputs required to control the MSM8128 SRAM.

<i>Mode</i>	$\overline{CS1}$	<i>CS2</i>	\overline{OE}	\overline{WE}	<i>V_{CC} Current</i>	<i>I/O Pin</i>	<i>Reference Cycle</i>
Not Selected	1	X	X	X	I_{SB1}, I_{SB2}	High Z	Power Down
Not Selected	X	0	X	X	I_{SB}, I_{SB1}	High Z	Power Down
Output Disable	0	1	1	1	I_{CC}	High Z	
Read	0	1	0	1	I_{CC}	D_{OUT}	Read Cycle
Write	0	1	X	0	I_{CC}	D_{IN}	Write Cycle

1 = V_{IH} , 0 = V_{IL} , X = Don't Care

Low V_{CC} Data Retention Characteristics - L Version Only ($T_A = -55^\circ\text{C}$ to $+125^\circ\text{C}$)

<i>Parameter</i>	<i>Symbol</i>	<i>Test Condition</i>	<i>min</i>	<i>typ</i>	<i>max</i>	<i>Unit</i>
V_{CC} for Data Retention	V_{DR}	$\overline{CS1} \geq V_{CC} - 0.2\text{V}$, $CS2 \geq V_{CC} - 0.2\text{V}$ or $0\text{V} \leq CS2 \leq 0.2\text{V}$, $V_{IN} \geq 0\text{V}$	2.0	-	-	V
Data Retention Current	I_{CCDR}	$V_{CC} = 3.0\text{V}$, $V_{IN} \geq 0\text{V}$, $\overline{CS1} \geq V_{CC} - 0.2\text{V}$, $CS2 \geq V_{CC} - 0.2\text{V}$ or $0\text{V} \leq CS2 \leq 0.2\text{V}$.	-	-	700	μA
Chip Deselect to Data Retention	t_{CDR}	See Retention Waveform	0	-	-	ns
Operation Recovery Time	t_R	See Retention Waveform	5	-	-	ms

Notes (1) $CS2$ controls address buffer, \overline{WE} buffer, $\overline{CS1}$ buffer and \overline{OE} buffer. If $CS2$ controls data retention mode, V_{in} levels ($\overline{WE}, \overline{OE}, \overline{CS1}, I/O$) can be in the high impedance state. If $CS1$ controls Data Retention mode, $CS2$ must be $\geq V_{CC} - 0.2\text{V}$ or $0\text{V} \leq CS2 \leq 0.2\text{V}$. The other input levels (address, $\overline{WE}, \overline{OE}, I/O$) can be in the high impedance state.

AC Test Conditions

Output Load

- * Input pulse levels: 0V to 3.0V
- * Input rise and fall times: 5ns
- * Input and Output timing reference levels: 1.5V
- * Output load: See Load Diagram
- * $V_{CC} = 5\text{V} \pm 10\%$

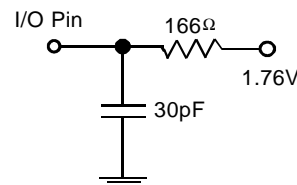

AC OPERATING CONDITIONS**Read Cycle**

Parameter	Symbol	70		85		10		12		Unit
		min	max	min	max	min	max	min	max	
Read Cycle Time	t_{RC}	70	-	85	-	100	-	120	-	ns
Address Access Time	t_{AA}	-	70	-	85	-	100	-	120	ns
Chip Select ($\overline{CS1}$) Access Time ⁽²⁾	t_{ACS1}	-	70	-	85	-	100	-	120	ns
Chip Select ($\overline{CS2}$) Access Time ⁽²⁾	t_{ACS2}	-	70	-	85	-	100	-	120	ns
Output Enable to Output Valid	t_{OE}	-	35	-	45	-	50	-	60	ns
Output Hold from Address Change	t_{OH}	5	-	5	-	10	-	10	-	ns
Chip Selection ($\overline{CS1}$) to Output in Low Z	t_{CLZ1}	10	-	10	-	10	-	10	-	ns
Chip Selection ($\overline{CS2}$) to Output in Low Z	t_{CLZ2}	10	-	10	-	10	-	10	-	ns
Output Enable to Output in Low Z	t_{OLZ}	5	-	5	-	5	-	5	-	ns
Chip Disable ($\overline{CS1}$) to Output in High Z ⁽³⁾	t_{CHZ1}	0	35	0	35	0	35	0	45	ns
Chip Disable ($\overline{CS2}$) to Output in High Z ⁽³⁾	t_{CHZ2}	0	35	0	35	0	35	0	45	ns
Output Disable to Output in High Z ⁽³⁾	t_{OHZ}	0	30	0	30	0	35	0	45	ns

Write Cycle

Parameter	Symbol	70		85		10		12		Unit
		min	max	min	max	min	max	min	max	
Write Cycle Time	t_{WC}	70	-	85	-	100	-	120	-	ns
Chip Selection to End of Write	t_{CW}	60	-	75	-	85	-	100	-	ns
Address Valid to End of Write	t_{AW}	60	-	75	-	85	-	100	-	ns
Address Setup Time	t_{AS}	0	-	0	-	0	-	0	-	ns
Write Pulse Width	t_{WP}	50	-	60	-	70	-	70	-	ns
Write Recovery Time (\overline{WE} , $\overline{CS1}$)	t_{WR1}	5	-	5	-	5	-	5	-	ns
($\overline{CS2}$)	t_{WR2}	5	-	5	-	5	-	5	-	ns
Write to Output in High Z	t_{WHZ}	0	30	0	30	0	35	0	40	ns
Data to Write Time Overlap	t_{DW}	30	-	35	-	40	-	45	-	ns
Data Hold from Write Time	t_{DH}	0	-	0	-	0	-	0	-	ns
Output Active from End of Write	t_{OW}	5	-	5	-	5	-	5	-	ns

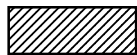

Consult Factory

Read Cycle Timing Waveform ^(1,2)

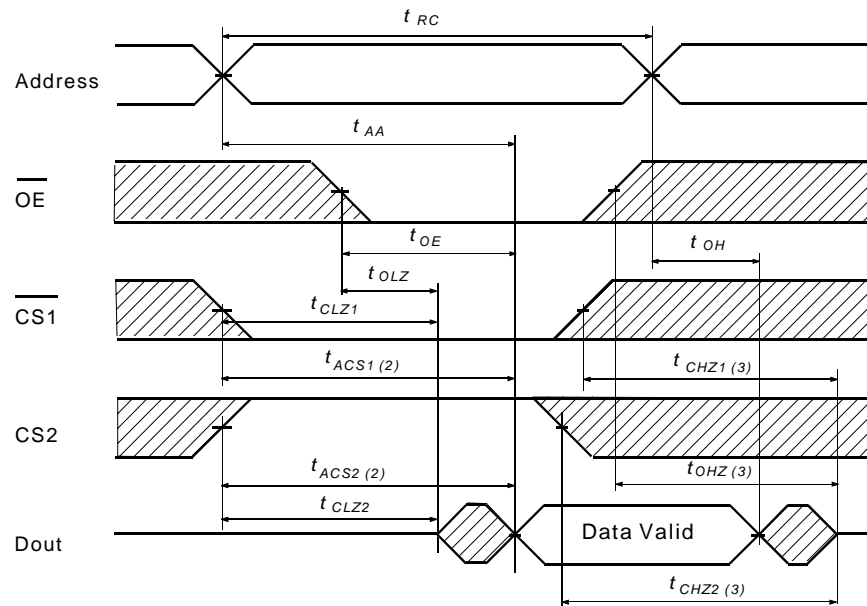

Notes:

- (1) \overline{WE} is High for Read Cycle.
- (2) Address valid prior to or coincident with $\overline{CS1}$ transition low or CS2 high.
- (3) t_{CHZ} and t_{OHZ} are defined as the time at which the outputs achieve the open circuit conditions and are not referenced to output voltage levels. At any given temperature and voltage condition, t_{CHZ} max is less than t_{CLZ} min both for a given device and from device to device. This parameter is sampled and not 100% tested.

Write Cycle No.1 Timing Waveform

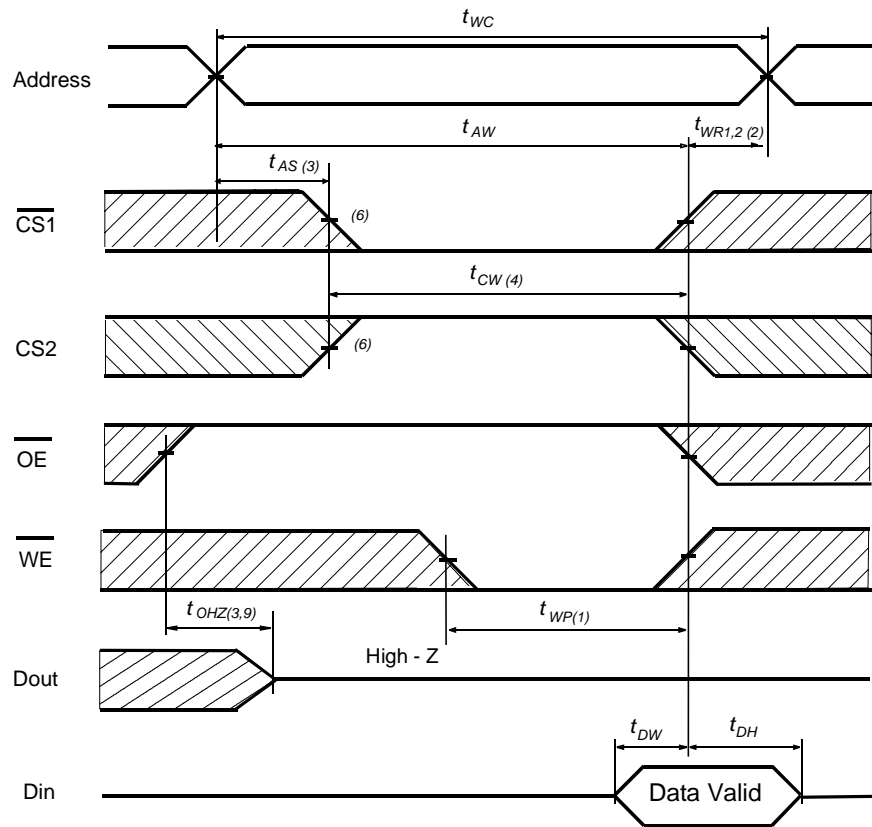

Write Cycle No.2 Timing Waveform ⁽⁵⁾

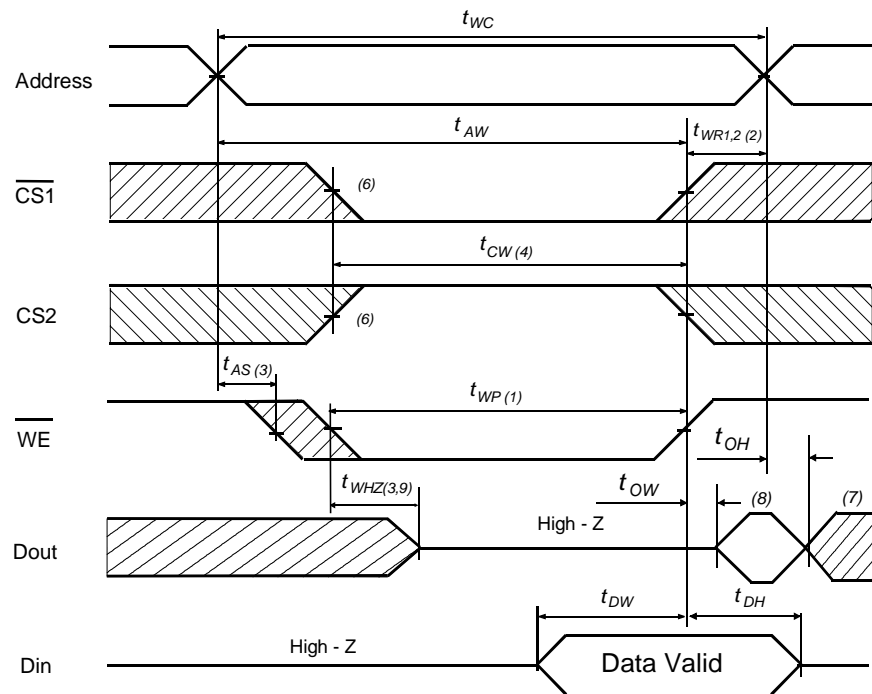

Low V_{CC} Data Retention Timing Waveform 1 ($\overline{CS1}$ controlled)

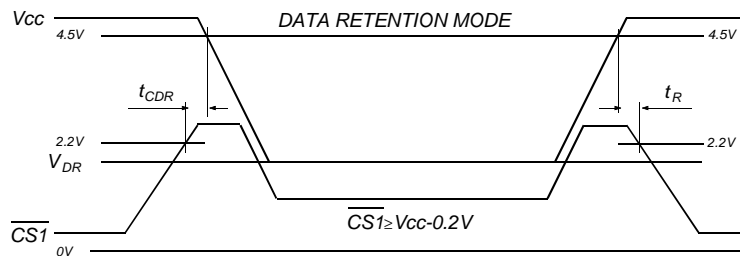

Low V_{CC} Data Retention Timing Waveform 2 (CS2 controlled)

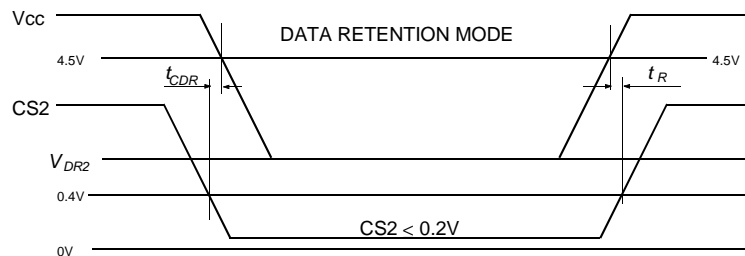

AC Characteristics Notes

- (1) A write occurs during the overlap of a low $\overline{CS1}$, a high CS2 and a low \overline{WE} . A write begins at the latest transition among CS1 going low, CS2 going high and \overline{WE} going low. A write ends at the earliest transition among CS1 going high, CS2 going low and \overline{WE} going high. t_{WP} is measured from the beginning of write to the end of write.
- (2) t_{WR} is measured from the earlier of $\overline{CS1}$ or \overline{WE} going high or CS2 going high to the end of write cycle.
- (3) During this period, I/O pins are in the output state. Input signals out of phase must not be applied.
- (4) If $\overline{CS1}$ goes low simultaneously with \overline{WE} going low or after \overline{WE} going low, outputs remain in high impedance state.
- (5) OE is continuously low. ($\overline{OE} = V_{IL}$)
- (6) Dout is in the same phase as written data of this write cycle.
- (7) Dout is the read data of next address.
- (8) If $\overline{CS1}$ is low and CS2 is high during this period, I/O pins are in the output state. Input signals out of phase must not be applied to I/O pins.
- (9) t_{WHZ} is defined as the time at which the outputs achieve the open circuit conditions and is not referenced to output voltage levels. These parameters are sampled and not 100% tested.

32 pin Flatpack - 'G' Package

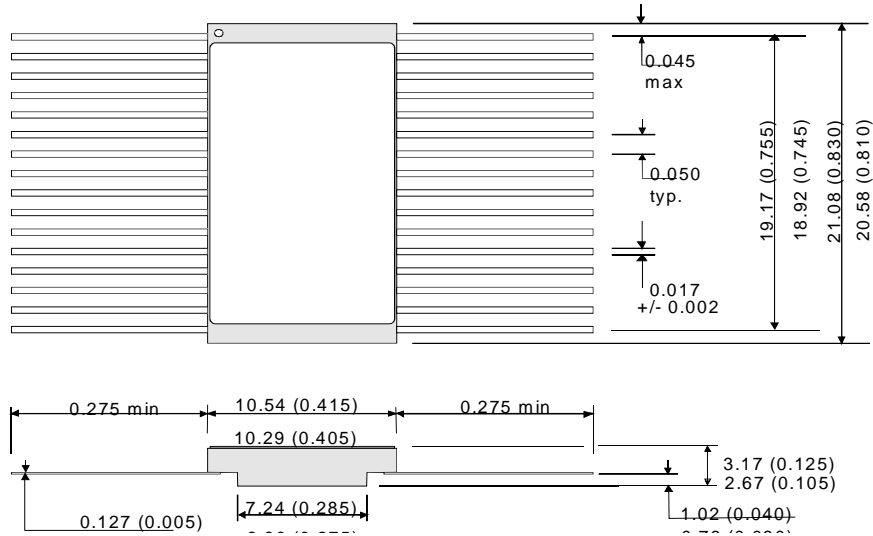

32 pad LCC (extended) -'W' Package

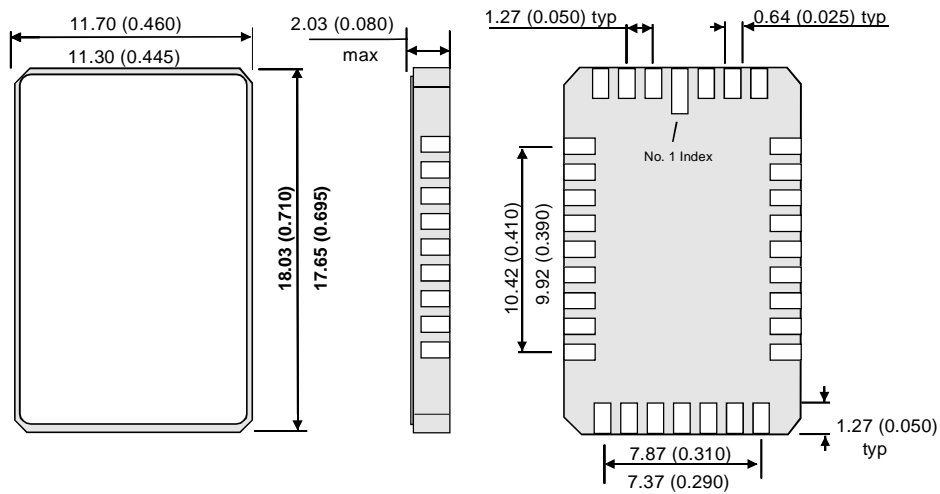

32 pad JLCC (extended) - 'J' Package

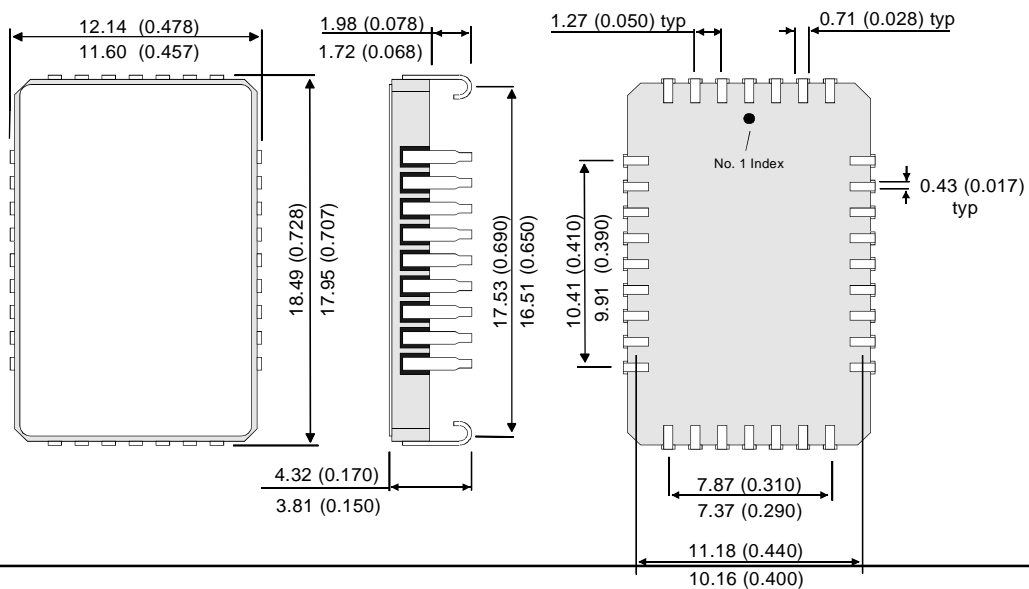

Alternate Pin Definition

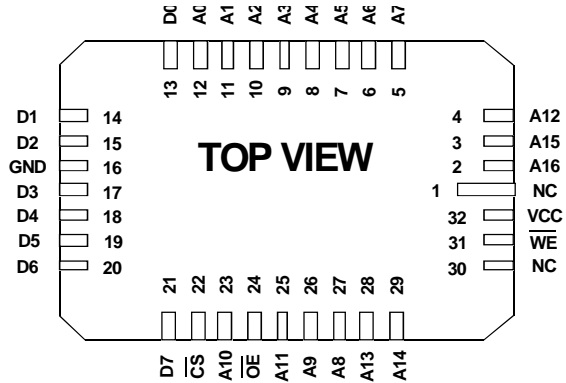
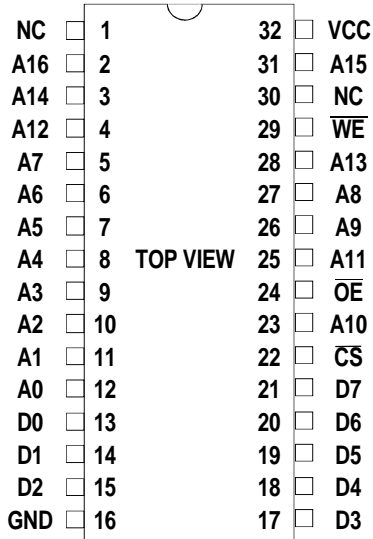

Military Screening Procedure

Component Screening Flow for high reliability product is in accordance with Mil-883 method 5004

MB COMPONENT SCREENING FLOW		
SCREEN	TEST METHOD	LEVEL
Visual and Mechanical Internal visual Temperature cycle Constant acceleration Pre-Burn-in electrical Burn-in	2010 Condition B or manufacturers equivalent 1010 Condition C (10 Cycles, -65°C to +150°C) 2001 Condition E (Y, only) (30,000g) Per applicable device specifications at $T_A=+25^\circ\text{C}$ Method 1015, Condition D, $T_A=+125^\circ\text{C}$, 160hrs min	100% 100% 100% 100% 100%
Final Electrical Tests Static (dc) Functional Switching (ac)	Per applicable Device Specification a) @ $T_A=+25^\circ\text{C}$ and power supply extremes b) @ temperature and power supply extremes a) @ $T_A=+25^\circ\text{C}$ and power supply extremes b) @ temperature and power supply extremes a) @ $T_A=+25^\circ\text{C}$ and power supply extremes b) @ temperature and power supply extremes	100% 100% 100% 100% 100%
Percent Defective allowable (PDA)	Calculated at post-burn-in at $T_A=+25^\circ\text{C}$	5%
Hermeticity Fine Gross	1014 Condition A Condition C	100% 100%
External Visual	2009 Per vendor or customer specification	100%

Ordering Information

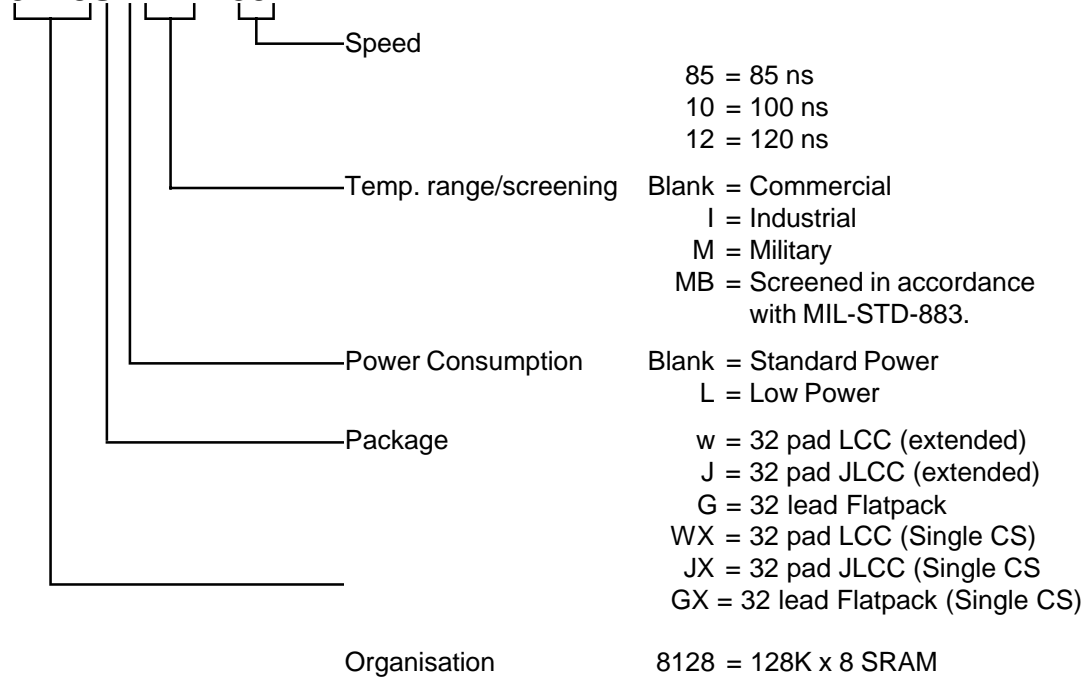
MSM8128SLMB - 85

THESE DEVICES ARE NOT RECOMMENDED FOR NEW DESIGNS AND MAY BE MADE OBSOLETE WITHOUT NOTICE....

Although this data is believed to be accurate the information contained herein is not intended to and does not create any warranty of merchantability or fitness for a particular purpose.

Our products are subjected to a constant process of development. Data may be changed at any time without notice. Products are not authorised for use as critical components in life support devices without the express written approval of a company director.